



General Description :

RM9003A is a one_stage LED constant current driving control chip which Compatible with silicon controlled dimmer application. Output current stay a constant in the range of 5m~100mA as once set by external SENSE resistor. It has the advantages of simpler system structure fewer peripheral components and simpler circuit.

Applications :

- LED Fluorescent tube T5/T8/T10...
- LED Bulb/Corn light/Candle lamp...
- Other small power LED lighting...

Features:

- Simpler peripheral circuit without magnetic components
- Chips can be used in series or parallel application
- Chips and LED can be welded in the same PCB board
- Output current can be set by external resistor
- Application circuit has no EMI problems
- Built_in 600V high voltage MOS
- Over temperature regulation
- Package: ESOP8、TO252、SOT89-3

Packaging information:



Pin Schematic Diagram:

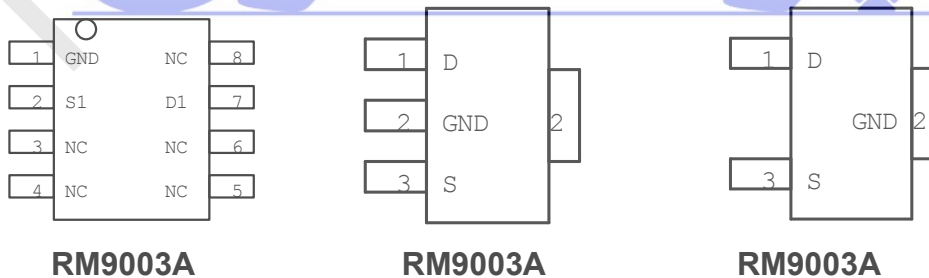



Pin Description:

PIN	Description
D	Drain of built_in MOS of D
GND	Ground for internal circuitry.
S1	Current sense input of Sample
NC	The vacant port

Marking Information

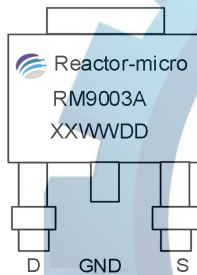

RM9003A=Product Type Marking Code
 XX=Different Packaging Plants Within The Enterprise
 WWDD=Date Code Marking
 WW=Last Two Digits of Year ,(eg:18=2018)
 DD=Specific Product Sequence

Ordering Information

Part Number	Case	Packaging
RM9003A	TO-252	2.5K
RM9003A	E-SOP8	4K
RM9003A	SOP89-3	4K

Limiting Values:

Symbol	Characteristic parameters	Range
S1	Current sense input.	-0.3v to 7v
TJ	Min/Max Operating Junction Temperature	-40°C to 150°C
Tc	Work Temperature	-40°C to 100°C
TSTG	Min/Max Storage Temperature	-55°C to 150°C

Note: Limit value is beyond the scope of work, may damage the chip. Recommend the scope of work is to point to in the scope, device function is normal, but does not guarantee completely satisfy the individual performance index. Electrical parameter defines the components within the scope of work and to ensure that the specific performance test under the condition of dc and ac parameter specification. For not given the parameters of the upper and lower limit, the specification is not guarantee its accuracy, but the typical value reasonably reflect the device performance.



Typical application:

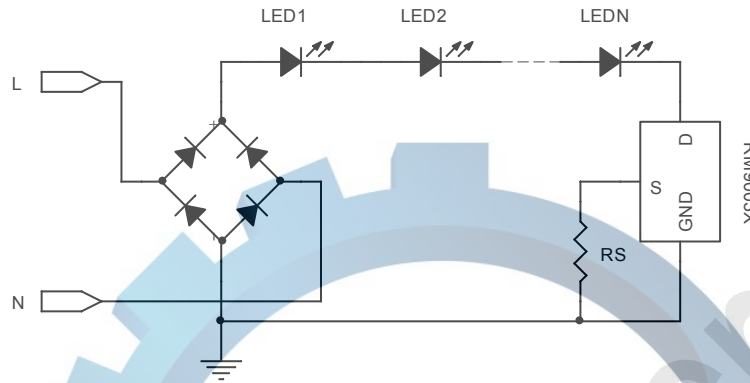

Figure1:single drive

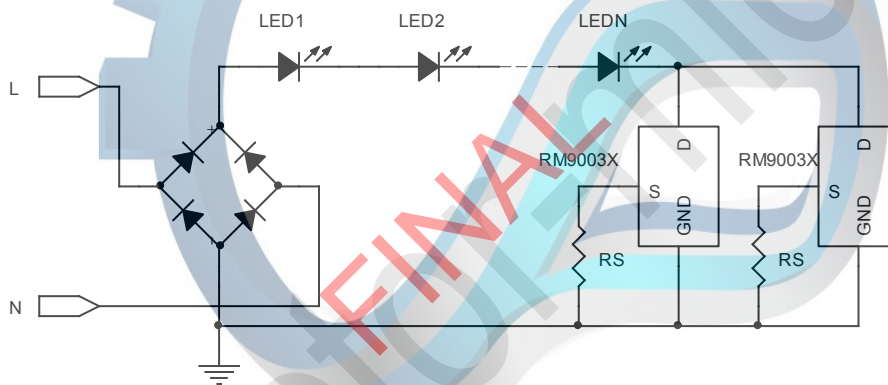

Figure 2: Two parallel drive

Electrical Operating Parameters:

(Ambient temperature is 25°C if there is no special instruction)

Symbol	Parameters	Test condition	Min	Typ	Max	Unit
V _{on}	Work the minimum voltage	S1=30mA	6	-	-	V
V _{ds}	Drive end peak voltage		600	-	-	V
I _s	Working current	100°C	5	-	100	mA
V _{ref}	Reference voltage	25°C	-	0.6	-	V
I _{dd}	Quiescent current	V _d =10V	-	0.3	-	mA
OTP	Over-temperature adjustment point		-	110	-	°C



Functional Block Diagram:

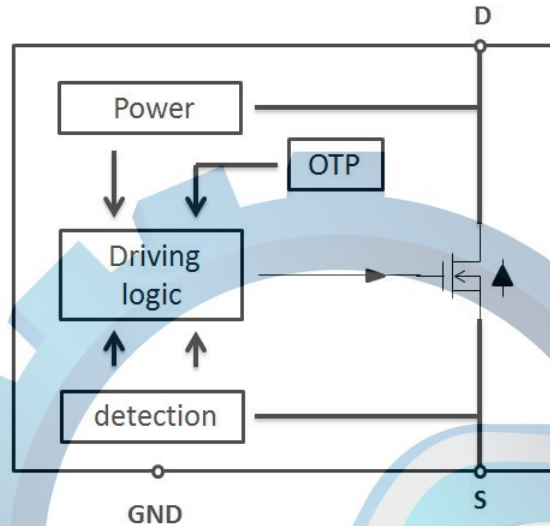

Application information:

In the linear circuit, the voltage at both ends of the IC is caused by the variation of the input voltage (or the residual voltage in addition to the LED string), so that the power consumption of IC changes, and in the whole circuit IC to assume the power of the remaining power, constant LED series current, control the temperature of the LED lamp characteristics.

Amount of selection:

Because the IC bear the residual voltage in the circuit, so in the design of the voltage of the LED string closer to AC rectifier after the voltage, so that the whole circuit running efficiency to achieve the best. Proposed chip power consumption is less than 1.5W.

The AC input voltage (V_{rms}), single LED grain to drop (V_f), forward current (mA). Then design the total number of LED grains:

$$N_{LED} = \frac{(V_{nor} \times 1.414 - V_A)}{V_f}$$

V_A : The voltage IC is assumed in the circuit, the bigger the voltage, the greater the loss of IC itself.

Constant current control function:

Chip built-in current limiting module, when the current flow through the chip is greater than the chip determines the maximum value, the chip off D feet and S feet, so that the circuit is in an instant off state, At the same time, once again, the D pin and the S pin are opened, so that the current of the whole linear circuit is switched on and off, so that the current flowing through the LED is constant.



Drain current of 9003A is precisely regulated through external resistor. Driving current calculation. Externally adjustable resistance R_s :

$$I_f = \frac{0.6V}{R_s}$$

Over temperature regulation:

In order to improve the working reliability, chip RM9003A used temperature control design, when the temperature of the chip is too high, gradually reduce the output current, so as to control the output power and temperature rise, make the chip temperature is too high, in order to improve system reliability. Inside the chip set a temperature adjusting temperature is 110 °C

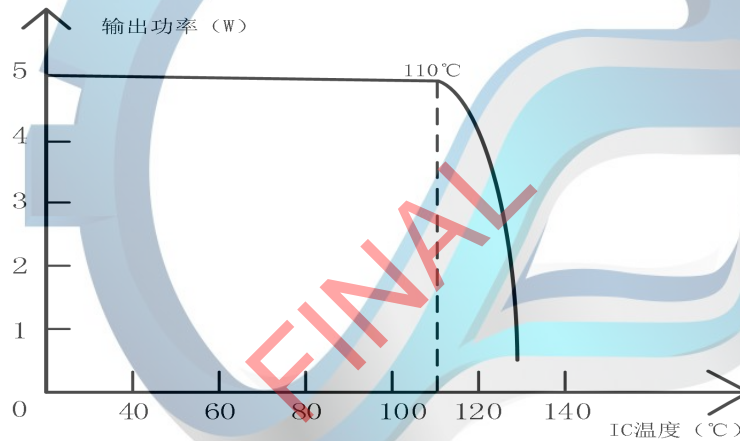

پارت سازان



RM9003A Package ESOP-8

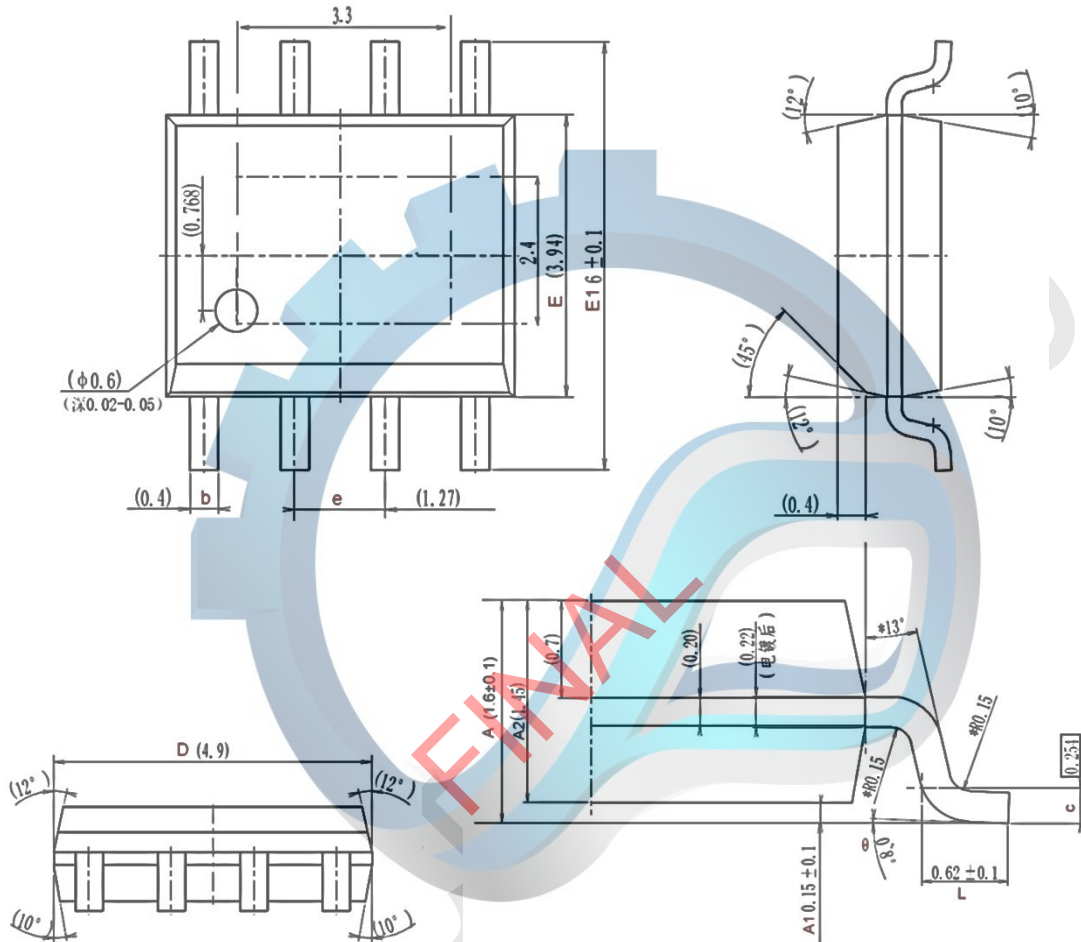

Sign	Millimeter		
	Min	TYP	Max
A	1.500	1.600	1.700
A1	0.050	0.165	0.250
A2	1.350	1.450	1.550
b	0.300	0.400	0.500
c	0.220	0.254	0.280
D	4.800	4.900	5.000
E	3.840	3.940	4.040
E1	5.900	6.000	6.100
e		1.27(BSC)	
L	0.520	0.620	0.720
θ°	0°		8°



RM9003A Package SOP89-3

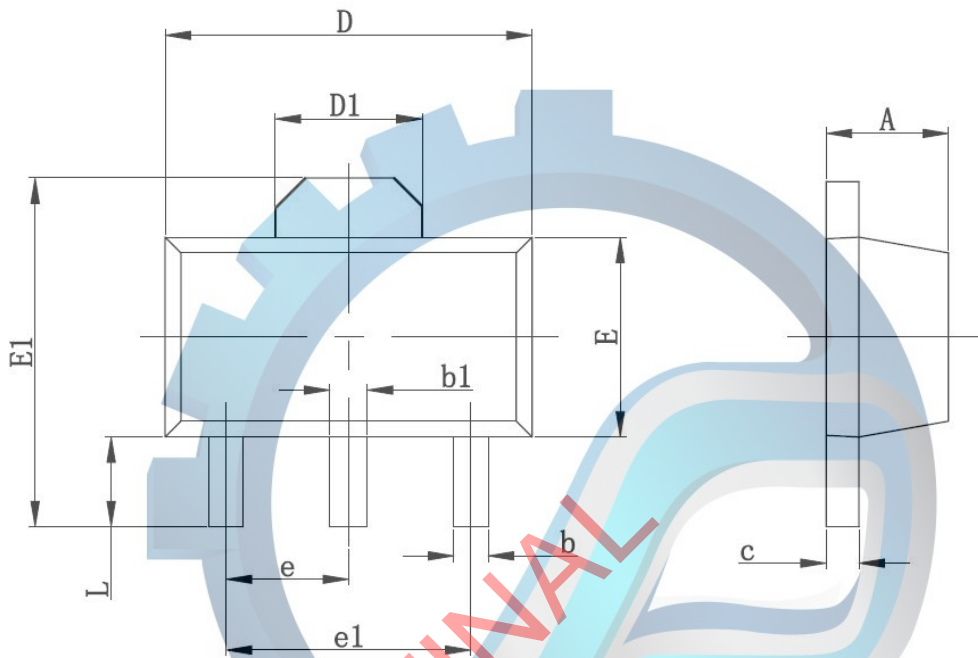

Sign	Millimeter	
	Min	Max
A	1.400	1.600
b	0.350	0.520
b1	0.400	0.580
c	0.350	0.440
D	4.400	4.600
D1	1.550REF	
E	2.350	2.550
E1	3.940	4.250
e	1.500TYP	
e1	3.000TYP	
L	0.900	1.100



RM9003A Package TO-252

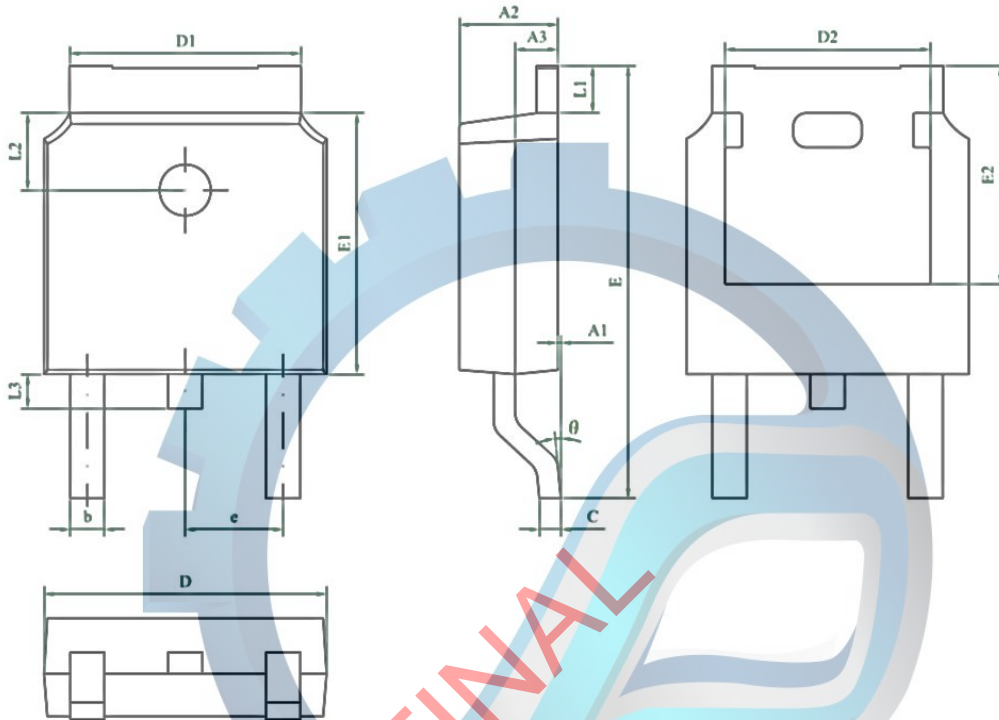

Sign	Millimeter		
	Min	TYP	Min
A1	0	----	0.10
A2	2.20	2.30	2.40
A3	0.90	1.00	1.10
b	0.75	----	0.85
c	0.50	----	0.60
D	6.50	6.60	6.70
D1	5.30	5.40	5.50
D2	4.70	4.80	4.90
E	9.90	10.10	10.30
E1	6.00	6.10	6.20
E2	5.20	5.30	5.40
e	2.20	2.286	2.40
L1	0.90	----	1.25
L2	1.70	1.80	1.90
L3	0.60	0.80	1.00
θ°	0°	----	8°