



型号 Model: E2835UX59-6A

日期 Date: 2019-10-08

部门 Department: RD

版本 Edition: A/0

承认 Acceptance

批量生产 Batch production

初步试样 Initial sample

客户专用设计 Customer Special Design

设计编号 Design Number:

MLS	批准 Approval	审核 Audit	制作 production
客户会签 Customer signature			
客户意见 Customer comment			

地址：广东省中山市小榄镇龙山工业区木林森大道 1 号

Address: XiaoLan town LongShan industrial zone Mulinsen road no. 1, Zhongshan City, Guangdong Province

总机 (switchboard): 0760-8982 8888

E-mail: mls@zsmil.com

http://www.zsmls.com

目录 Contents

产品介绍 (Product Introduction)	2
光电参数 (Photoelectric Parameters)	4
电性曲线 (Electrical Curve)	5
色区坐标 (Color Coordinates)	7
Bin 等级 (Bin Level)	8
实验标准(Experimental Standard)	9
包装规格 (Packing Specification)	10
使用说明 (Instructions For Use)	12
储存方式 (Storage)	16
硫化标准 (Vulcanization Experiments)	17

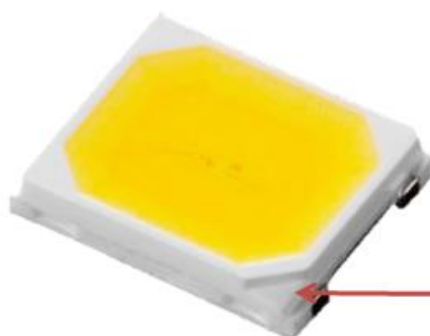
简述 (Description): 平面发光二极管 (Flat LED)

Cathode Mark

- 高光效, 高亮度, 色温可选;
- 体积小, 便于设计和安装;
- 高可靠性, 长寿命;
- 适用于照明例如球泡灯、筒灯、洗墙灯等;

产品选择 (Product Selection Guide)

产品分类 Types	色温 CCT (K)	光通		电压 VF	测试电流 Current (mA)
		Min	Max		
E2835UW59-6A	6500	55	70	18	30
E2835UN59-6A	4000	55	70		
E2835US59-6A	3000	50	65		

备注(Remarks):

 1、CRI x,y 测量误差 ± 0.003

 Measurement tolerance, x, y ± 0.003 requirement

2、色温保证误差正负 5%。

The error of color temperature is less than or equal to 5%。

 3、发光亮度保证误差 $\pm 4\%$ 。

Brightness tolerance is guaranteed within plus or minus 4%。

 4、VF 测试误差 $\pm 0.1V$

 Tolerance of measurement of VF $\pm 0.1V$

 5、显指误差范围 ± 2

 Color Rendering Index error range ± 2

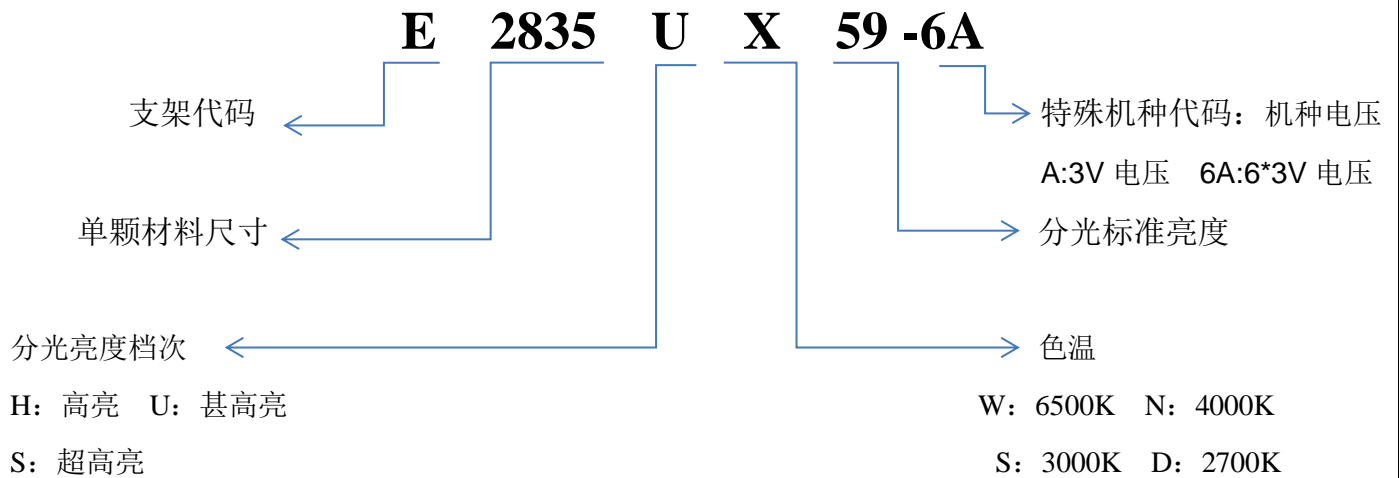
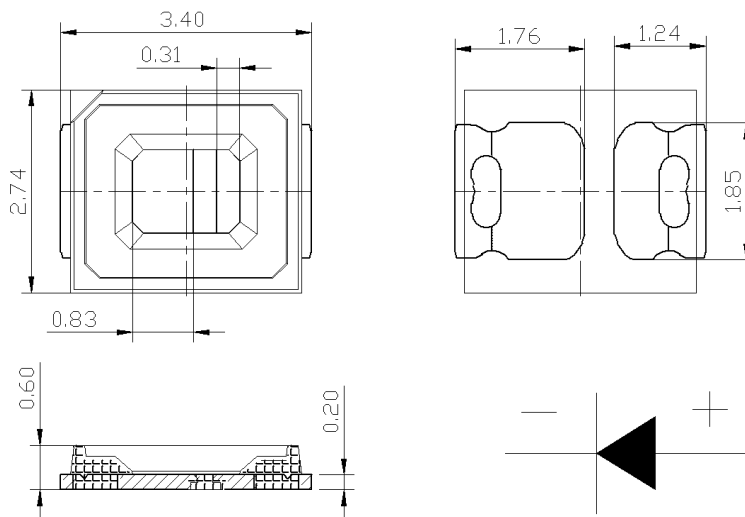
命名规则 (Product Nomenclature)

封装尺寸 (Package Dimensions)

备注(Remarks):

- 1、所有尺寸单位为毫米
All dimensions are in millimeters
- 2、未注明公差为 ± 0.1 毫米 (除非另有说明)
Tolerance of + or - 0.1mm (unless otherwise noted)
- 3、规格若有变更恕不另行通知
Specifications subject to change without prior notice

温度为 25°C 时的最大参数值 (Absolute Maximum Rating Value Temperature at 25°C)

参数 (Parameters)	极限参数 (Maximum Rating)	单位 (Units)
功耗(Power)	500	mW
顺向直流电 (Forward Current)	30	mA
正向脉冲电流 $\leq 10\text{ms}$, 工作周期=1/10(Pulse Forward Current($t_p \leq 10\text{ms}, \text{Duty cycle}=1/10$))	30	mA

温度为 25°C 时的光电特性参数 (Optical Parameters Temperature at 25°C)

参数 Parameter	符号 Symbols	最小值 Min	标准值 Typical	最大值 Max	单位 Units	测试条件 Testing Conditions
发光角度 (Viewing Angle)	2 θ 1/2	---	120	---	Deg	IF=30mA
工作电流 (Working Current)	IF	---	30	---	mA	---
正向电压 (Forward voltage)	VF	17	---	20	V	IF=30mA
光通量 (Luminous Flux)(UW)	Φ	---	65	---	LM	IF=30mA
光通量 (Luminous Flux)(US)	Φ	---	60	---	LM	IF=30mA
结温 (Junction temperature)	Tj	---	---	120	°C	IF=30mA
热阻 (Thermal Resistance)	T _{Sol}	---	---	20	°C/W	IF=30mA

备注 (Remarks):

1、此发光亮度为根据人眼对发光亮度的感应曲线之模拟发光强度符合 CIE (国际光委会组织)。

Light-emitting brightness is according to human eye simulation of the induction curve of luminous intensity in line with the CIE (International Light Committee Organization)。

2、1/2 的角度是从光学中心线处的发光强度为 1/2 光学中心线值。

1/2 angle is from optical centerline at the luminous intensity is 1/2 the optical centerline value.

3、发光亮度保证误差正负 4%。Brightness tolerance is guaranteed within plus or minus 4%。

4、以上所测光学数据以 MLS 的测试设备为准。

The optical measurement data by MLS equipment test.

典型的电性及视角曲线 (Typical Electrical and Perspective Curve)

如果没有特别说明, 环境温度为 25°C

Unless Otherwise Specified, Ambient Temperature is 25 °C

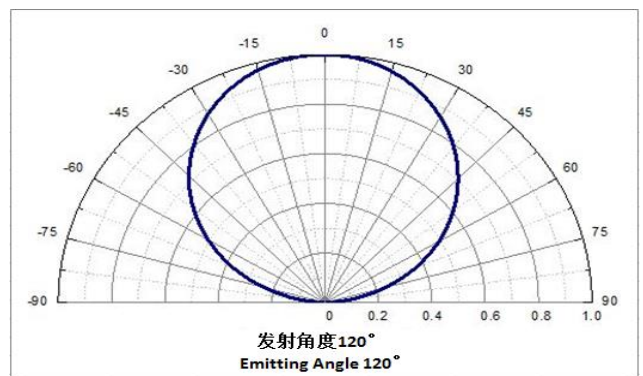
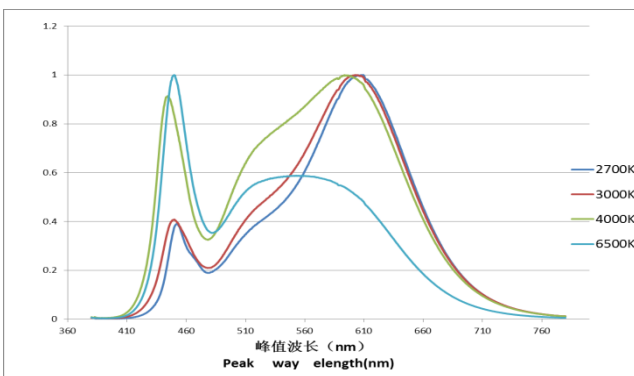
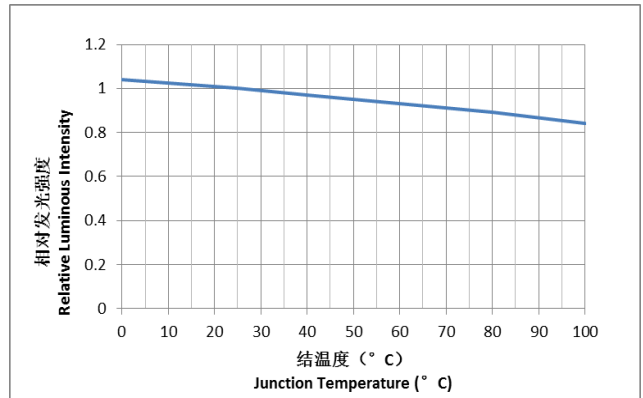
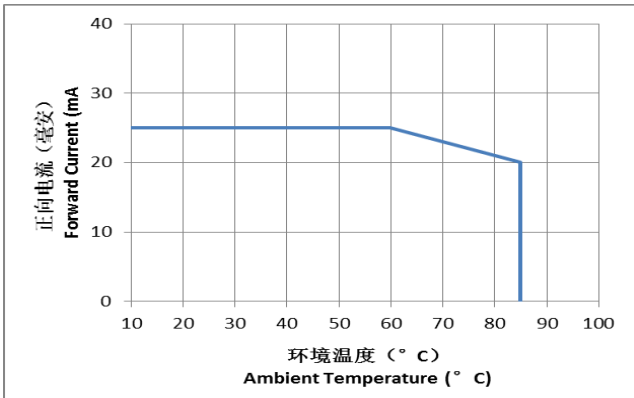
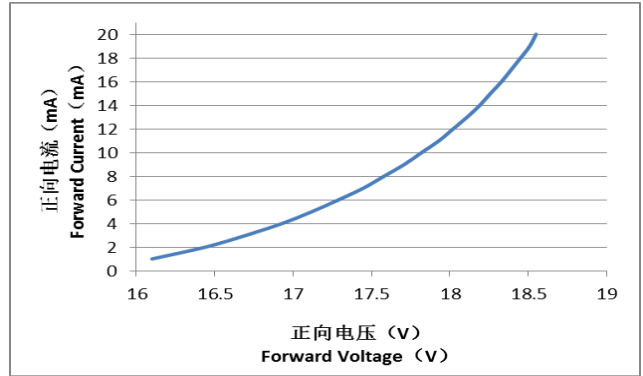
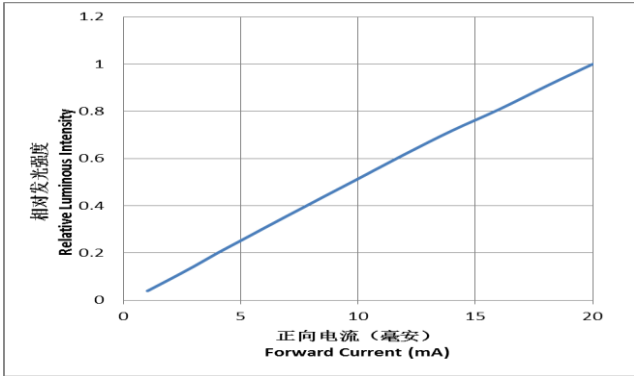

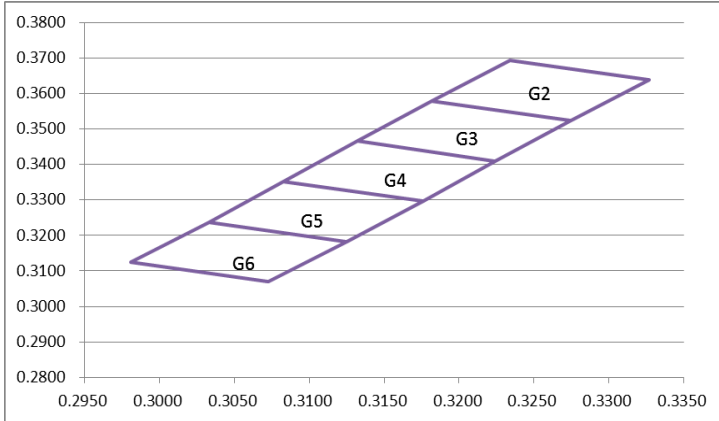
色品图 (CIE Chromaticity Diagram)
1、E2835UW59-6A

G2: 5691-5917K
G3: 5917-6173K
G4: 6173-6475K
G5: 6475-6847K
G6: 6847-7326K

区域	①		②		③		④	
	X	Y	X	Y	X	Y	X	Y
G6	0.2981	0.3124	0.3033	0.3238	0.3033	0.3238	0.3125	0.3183
G5	0.3033	0.3238	0.3083	0.3352	0.3176	0.3296	0.3125	0.3183
G4	0.3083	0.3352	0.3132	0.3465	0.3224	0.3410	0.3176	0.3296
G3	0.3132	0.3465	0.3182	0.3579	0.3275	0.3523	0.3224	0.3410
G2	0.3182	0.3579	0.3234	0.3693	0.3327	0.3637	0.3275	0.3523

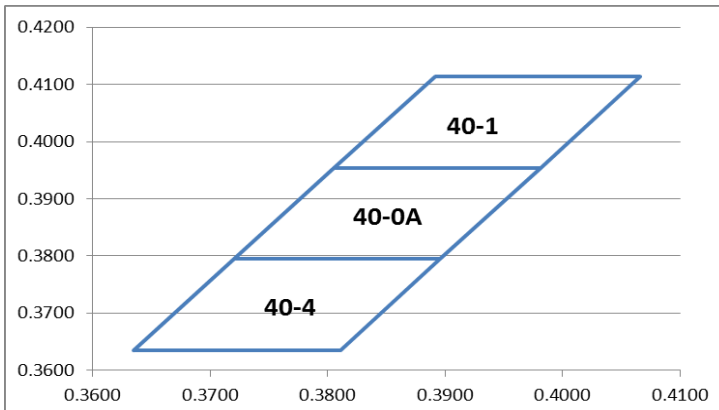
2、E2835UN59-6A

40-1: 3700-3900K
40-0A: 3900-4200K
40-4: 4200-4300K

区域	①		②		③		④	
	X	Y	X	Y	X	Y	X	Y
40-1	0.3959	0.4242	0.4185	0.4243	0.4049	0.3989	0.3823	0.3989
40-0A	0.3823	0.3989	0.4049	0.3989	0.3913	0.3733	0.3687	0.3733
40-4	0.3687	0.3733	0.3913	0.3733	0.3777	0.3479	0.3551	0.3479

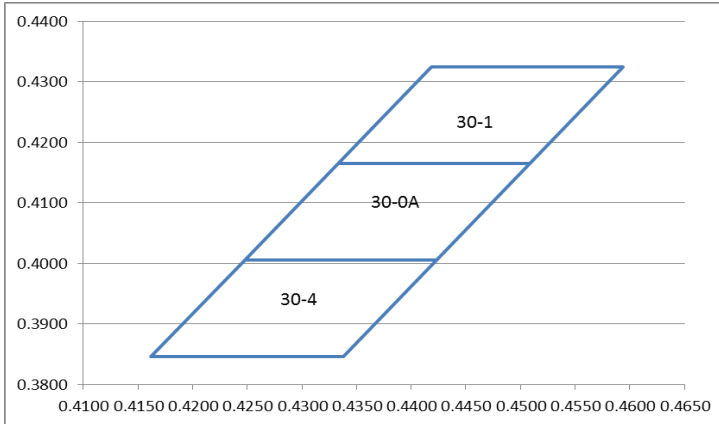
3、E2835US59-6A

30-1: 2929-2939K
30-0A: 2939-2953K
30-4: 2953-2967K

区域	①		②		③		④	
	X	Y	X	Y	X	Y	X	Y
30-1	0.4333	0.4165	0.4419	0.4325	0.4594	0.4325	0.4509	0.4165
30-0A	0.4248	0.4006	0.4333	0.4165	0.4509	0.4165	0.4423	0.4006
30-4	0.4162	0.3846	0.4248	0.4006	0.4423	0.4006	0.4338	0.3846

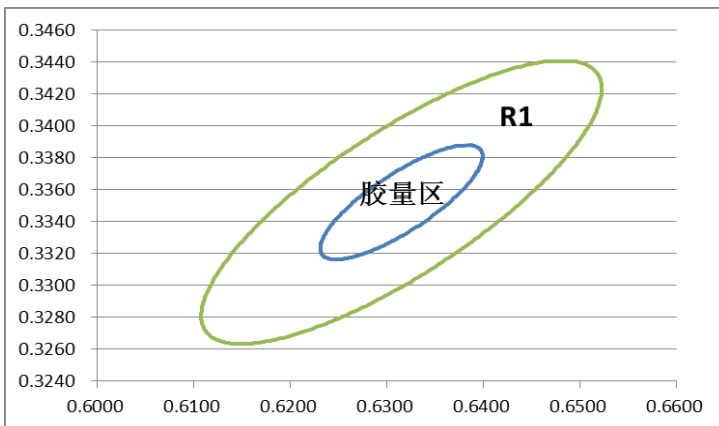
4、E2835UR59-6A

红光 (R1)	CCT	Color Space	Center Xc	Center Yc	Major Axis	Minor Axis	Rotation Angle	Radians
	/	/	0.6315	0.3352	0.022	0.003	20	0.3491
胶量区	/	/	0.6315	0.3352	0.00892	0.002	20	0.3491

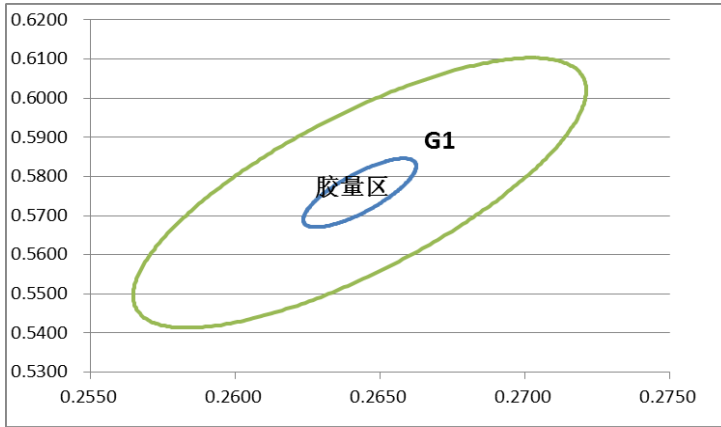
5、E2835UG59-6A

绿光 (G1)	CCT	Color Space	Center Xc	Center Yc	Major Axis	Minor Axis	Rotation Angle	Radians
	/	/	0.2643	0.5758	0.035	0.005	80	1.3963
胶量区	/	/	0.2643	0.5758	0.00892	0.0012	80	1.3963

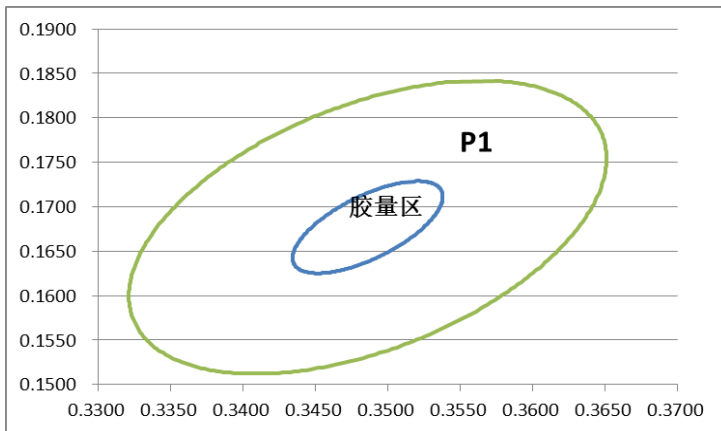
6、E2835UP59-6A

粉光 (P1)	CCT	Color Space	Center Xc	Center Yc	Major Axis	Minor Axis	Rotation Angle	Radians
	/	/	0.3486	0.1677	0.02	0.012	45	0.7854
测胶量区	/	/	0.3486	0.1677	0.00669	0.003	45	0.7854

BIN 等级 (BIN grade)

参数 Parameter	符号 Symbols	等级 grade	实际参数 Actual parameter	单位 Units	测试条件 Testing Conditions
光通量 (Luminous Flux)	Φ	E55(50-55LM)	50-55	Lm	IF=30mA
		E60(55-60LM)	55-60	Lm	IF=30mA
		E65(60-65LM)	60-65	Lm	IF=30mA
		E70(65-70LM)	65-70	Lm	IF=30mA
电压 (Forward Voltage)	VF	17-18	17-18	V	IF=30mA
		18-19	18-19	V	IF=30mA
		19-20	19-20	V	IF=30mA

备注 (Remarks)

1.需安装在金属基板上来保证良好散热

Metal Core PCB is mounted on the heat Fins

可靠性测试项目及测试条件(Reliability Test Items and Test Conditions)

编号 Number	测试项目 Test Item	实验条件 Test Conditions	样本大小 Sample size	允收/判退 Acceptance/Rejection
01	回流焊 Reflow Solder	温度: 最大 260°C Temperature: Max 260°C 时间(Time): ≤10S 周期(Cycles): 3 次 (3times)	22PCS	0/1
02	寿命测试 Life Test	温度(Temperature)=25°C ±5°C 电流(Current)=30mA±2mA 周期(Cycles): 1000H	22PCS	0/1
03	温度循环 Temperature Cycling	85°C ~ 25°C ~ -40°C ~ 25°C 30 mins 5 mins 30 mins 5 mins 周期(Cycles): 20 个周期 (20 Cycles)	22PCS	0/1
04	冷热冲击 Hot/cold Temperature Shock	-40°C ±5°C(15 mins) ~100°C ±5°C(15 mins) 两温度转换时间 (Transfer time) <10s 周期(Cycles): 250 个周期 (250 Cycles)	22PCS	0/1
05	低温储存 Low Temperature Storage	温度(Temperature): -40°C ±5°C 周期(Cycles): 1000H	22PCS	0/1
06	高温储存 High Temperature Storage	温度(Temperature): 100°C ±5°C 周期(Cycles): 1000H	22PCS	0/1
07	高温老化 High Temperature Operating Life	温度(Temperature): 85°C 电流 (IF): 30mA 周期(Cycles): 1000H	22PCS	Failure: 0/1 ΔLumen: ≥80% ΔVF : ≤10% Δu'v' : < 0.007
08	高温高湿 Temperature Humidity Operating Life	温度(Temperature): 85°C 湿度 (Humidity): 85% 电流 (IF): 30mA 周期(Cycles): 1000H	22PCS	Failure: 0/1 ΔLumen: ≥80% ΔVF : ≤10% Δu'v' : < 0.007

备注: 参数规格若有变更恕不另行通知。

Remarks: Specifications are subject to change without prior notice.

标签 Label

Model:产品型号
 Lot NO:生产批号
 IV: 发光强度等级
 VF: 正向电压等级
 X/Y (HUE): 发光颜色等级或者波长等级
 Date Code: 生产日期/部门编号/机台编号/班次
 Quantity: 数量
 Remarks: 备注

Model:	*****
Lot No :	*****
IV :	*****
VF :	*****
X/Y(HUE):	*****
Date Code:	****/**/**
Quantity:	***** PCS
Remarks:	



PQC
Pass (50)
RoHS

编带规格 Taping Specifications (单位 Unit: mm)

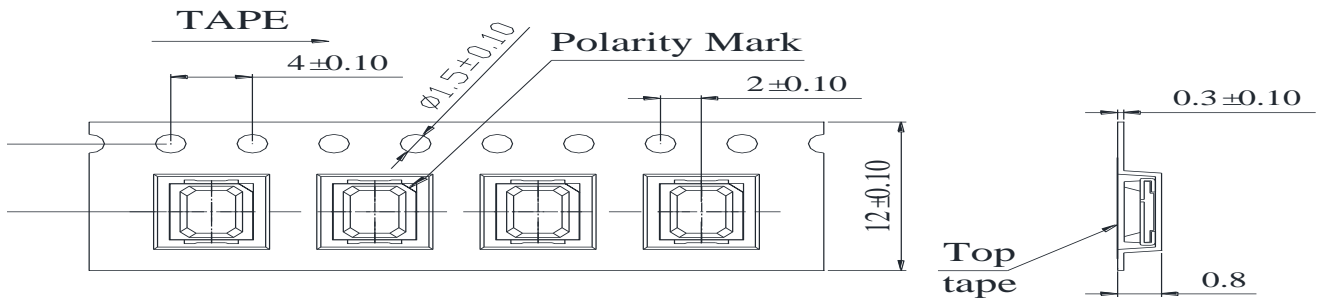

卷轴尺寸 Reel Size (单位 Unit: mm)

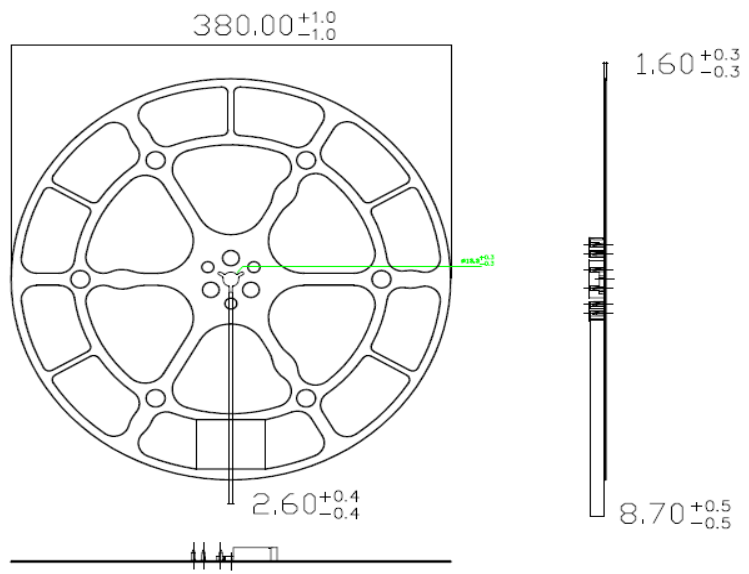

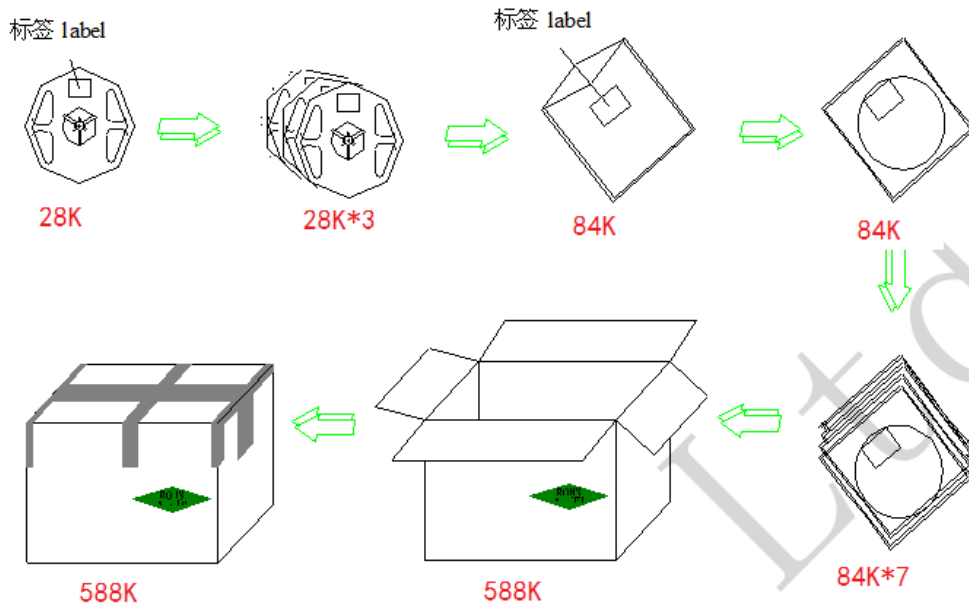
防潮包装 (Humidity Proof packaging)

注意事项(Note)

封装发光二极管的材料是硅性质，因此发光二极管的表面柔软而有弹性。虽然有机硅的特点能降低热应力，但是更容易受到机械外力的破坏，在表面上施加压力将会影响发光二极管的可靠性。在这样的情况下，装配使用有机硅封装的发光二极管产品时必须遵守相应的处理措施，避免任何的施加给发光二极管的任何部分，所以在使用时请采用气动吸咀。否则会导致发光二极管损坏和可靠性降低影响其寿命。

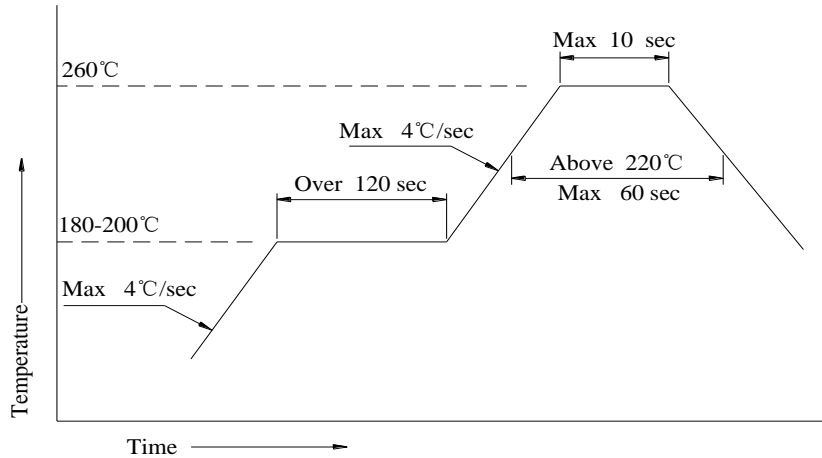
Packaged LED material is silicone nature, therefore, LED has is a soft and flexible surface. Although characteristics of silicone is to reduce thermal stress, but it is more susceptible to mechanical damage to the external forces applied on the surface. Pressure affects the reliability of light emitting diodes. In such circumstances, the assembly of organic silicon encapsulated LED products must comply with the appropriate measures to deal with. Avoid any pressure applied to any part of the LED and use pneumatic nozzle. Otherwise it may lead to reduction in reliability, and impact of its life to the LED.

回流焊说明(Reflow soldering instructions)

1、回流焊建议使用免清洗助焊剂，并依照回流焊曲线进行焊接，焊接次数不可超过 2 次。

Reflow soldering is recommended to the use of clean free flux, and in accordance to the reflow curve.

Maximum number of soldering is limited .

2、焊接时，不要在加热过程中对其施加压力。

When soldering, do not exert pressure during heating process.

烙铁焊接 (Soldering)

1、当手动焊接时，建议采用 20W 的防静电烙铁，焊头的温度必须控制在 360°C 以下/3 秒，焊接次数为 1 次。

When manual soldering iron is used, it is recommended to use 20W anti-electro static soldering iron, soldering temperature must be kept below 360 °C / 3 seconds, 1Time soldering only.

2、不可在同一单元板上焊接不同 BIN 的材料，否则会导致 LED 色差。

Do not mix different BIN materials on the same board, otherwise it will cause LED color Variation.

修复 (Repair)

当修复发光二极管时，应事先确认发光二极管是否会被破坏，修复过程中应避免接触胶体表面，双焊头烙铁应使用如下图的方式作业。

When repairing light-emitting diodes, it is advised to confirm the light emitting diode will be damaged, the repair process should avoid contact with the colloid surface, use of soldering iron should be according to following diagram.

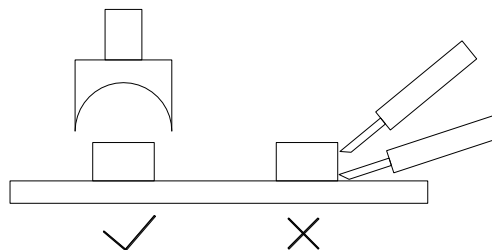

清洗 (Clean)

在焊接后推荐使用纯酒精清洗，清洗擦拭或浸渍不要超过 1 分钟。使用其它类似溶剂清洗前，请确保溶剂不会对发光二极管封装造成损伤。

Recommend the use of pure alcohol to clean, wash and wipe or dipping no more than 1 minutes after soldering. When different solvents are used for cleaning, make sure that solvents do not damage the light emitting diode packaging.

灌封 (Potting)

- 1、使用硅酮胶（玻璃胶）灌封时推荐采用中性、醇型类灌封胶。

The use of silicone rubber (plastic glass) for potting, it is recommended the use of alcoholic encapsulating Material.

- 2、灌封胶若使用脱肟型中性灌封胶，请确保灌封胶固化过程中的通风良好，在未完成固化过程中不可进行密封组装发光二极管元件。这样会造成镀银层氧化及发光颜色变淡。

When deoximation neutral potting material is used, make sure that the potting curing process in well-ventilated. Do not perform sealing assembly of Light Emitting Diodes before potting is completely cured and setting process is completed. This will result in the silver layer oxidation and luminous color fades, light degradation and even dead LED.

- 3、禁止使用醋酸型（酸性）硅酮胶进行灌封。

Prohibit the use of acetic acid type (acidic) silicone rubber potting materials.

- 4、使用正常灌封胶时建议进行少量灌封试验，常温点亮测试 168H 确认无异常后再批量作业。

It is recommended that small quantity samples are made for potting test, Room temperature light test of 168H confirming no abnormality before mass products.

- 5、更改任何一种灌封材料时，请先作试样确认是否对我司产品造成侵蚀反应。将灌封材料取 5-10g 和发光二极管 10-20pcs 于 100ml 的器皿内密封放置 168H 后确认产品是否有异常。

When there is change in potting material, please make samples to confirm whether there is erosion reaction. Take 5-10 grams of potting material and 10-20 pcs in a 100ml sealed containers for 168H confirm whether there is abnormality.

驱动方式 (Driving method)

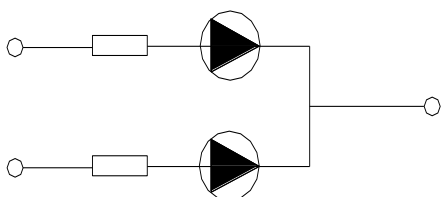

(A)

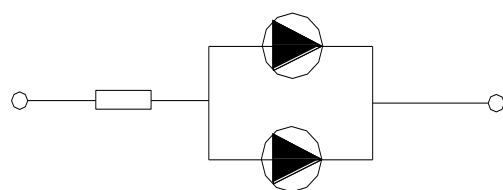

(B)

(A) 被推荐的电路

Recommended circuits

(B) 每个灯珠可能出现亮度不一致，是由 I-V 的曲线而导致的

Each LED may appear inconsistent brightness, it is a result of the IV curve

静电(Static electricity)

对于整个工序（生产,测试、包装等）所有与 LED 直接接触的员工都要做好防止和消除静电措施，主要有
All employees have direct contact with LED for all processes (production, testing, packaging, etc.) must perform all preventive and eliminating static electricity measures.

1、车间铺设防静电地板并做好接地，工作台采用防静电工作台，带电产品接触低阻值的金属表面时，由于急放电引发产品故障的可能性是很高的，故要求工作台及与产品相接触之处使用表面电阻为 10^6 - $10^9\Omega$ 的桌垫。

Workshop floors to use of the anti-static flooring and grounding, anti-static work bench, when charged material is in contact with low resistance metal surface, due to acute discharge, possibility of product failure is very high, so the requirements of the bench and any contact with the products should have surface resistance of 10^6 - $10^9\Omega$ table mats.

2、生产机台如：锡炉、回流焊、SMT 设备、电烙铁，以及检测设备均需接地良好，接地交流阻抗小于 1.0Ω 。在容易产生静电的环境与设备上，还必须安装离子风扇、作业过程中，操作员穿防静电服、带防静电手环、手套等，取放时尽可能接触产品的绝缘部分。

Production machines such as: tin furnace, reflow soldering, SMT equipment, electric soldering iron, and testing equipment need to be grounded, grounded AC impedance less than 1.0 ohm. Prone to static electricity environment and equipment must be installed ion fan. During working process, operators to wear anti-static clothing, wrist strap, gloves, and etc., When handling, hold the insulated part of the product as much as possible.

3、盛装 LED 使用防静电元件盒，包装则采用防静电材料。

For packaging of LED, anti-static component boxes, packaging materials should be use.

4、请保持环境湿度在 60%RH 以下，以免空气过于干燥产生静电。

Keep ambient humidity below 60% RH to avoid air being too dry to generate static electricity.

5、静电接地需与电源零线、防雷地线分开，接地措施应完全防止静电产生，必须用粗的铜线引入泥土内，在铜线末端系上大铁块，埋入地表 1 米以下，各接地线均需与主线连接在一起。

Grounding should be connected to the neutral input line. It should be separated from the lightning grounding. Grounding should be done with anti-static. Heavy gauge copper cable should be connected to a large piece of metal and buried at least 1 meter deep into the ground. All ground cables must be connected together with the main cable.

使用操作示意图 (Operating diagram)

- 1、使用镊子或合适的工具，沿侧表面夹取元件。

Use forceps or other appropriate tools grip along the side surface of component.

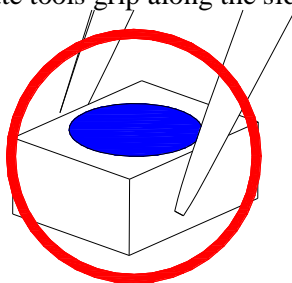

- 2、不要接触有机硅的表面，它可能会破坏发光二极管的内部电路。

Do not touch the silicone surface. It may damage the internal circuitry of the LED.

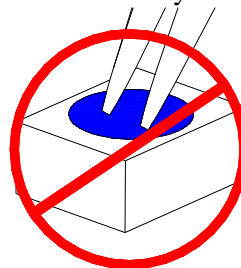
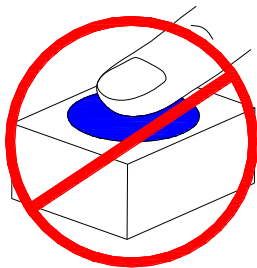

- 3、不要将焊接好的发光二极管堆叠放置，会导致发光二极管划伤及胶体受损造成死灯。

Do not stack soldered LED, it may cause scratching of LED and silicone damage leading to dead LED .

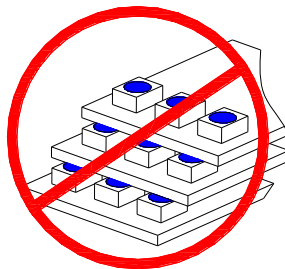

- 4、不可接触和使用天那水、三氯乙烯、丙酮、硫化物、钠离子及酸、碱、盐等物质，这样会造成镀银层氧化及荧光粉硫化。致使发光二极管发光颜色变淡、亮度变暗等现象发生。

Do not make contact with thinner, Trichloroethylene, acetone, sulfide, sodium ion and acid, alkali, Salt and other substances. These materials will cause oxidation of silver plating and vulcanization of phosphor leading to color fading and reduction of brightness conditions.



储存 (Storage)

1、建议未拆封前储存条件：小于 30°C/60%RH 下，保存期限为一年。

Recommended storage conditions before opening packaging: <30 °C / <60% RH, retention period of one year.

2、拆封后在室温 <30°C，湿度 60%RH 以下，建议在 4H 内完成回流焊作业，12H 内完成封装作业。因发光二极管吸湿后回流焊高温会导致硅胶与 PPA 分层，元器件失效。对于未使用之产品，请采取除湿处理（卷轴产品 75°C ±5°C/12H，散装产品 110°C ±5°C/1H，在烤箱内作自然冷却 1H）后再进行使用。

After opening of packaging: Room temperature <30 °C, humidity < 60% RH. It is recommended to complete the reflow soldering operations in 4Hours. Complete LED packaging operations within 12 hours. If LED absorbed moisture prior to high temperature reflow soldering process, it will cause silicone and PPA to separate leading to component failures. Unused products, perform dehumidification procedure (reel products 75 °C ±5 °C / 12H, bulk products, 110 °C ±5 °C / 1H, natural cooling 1H inside oven) before reuse.

3、使用时若发现有包装袋真空失效时，请不要使用，需要进行除湿后才可使用。

In the case of vacuum packing leakage, do not use, Use only after.

硫化实验

实验示意图如下图所示：

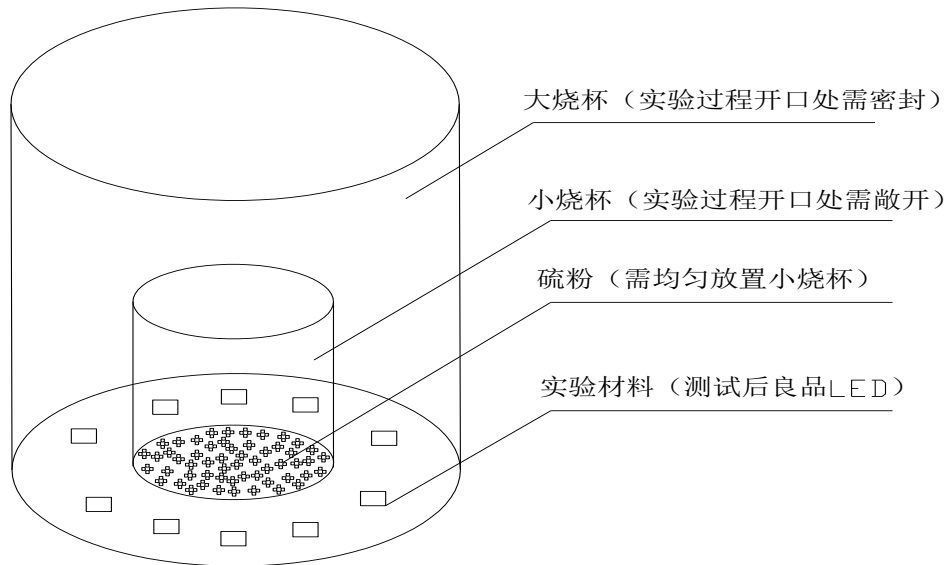

将 1g 硫粉均放于小烧杯底部，然后将小烧杯正置大烧杯中间。大小烧杯空隙间均匀放入 10 个 LED 灯珠并密封大烧杯后放置 85℃ 烤箱烤 4 小时

put 1g sulphur into bottom of small beaker, then put the small beaker into middle of a big beaker. Between the small and big beaker, put 10 LED equally and make the big beaker sealed then put into oven for 4 hours in 85℃ condition.

判定标准：硫化 4H 后光通量维持率需 $\geq 80\%$ ，即最大允许衰减 20%。